

Załącznik nr 2K.

Zestawienie studzienek betonowych w projektowanej kanalizacji sanitarnej dla wsi Stara Bystrzyca



Oznaczenia:

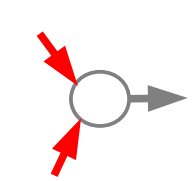
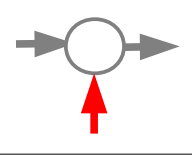
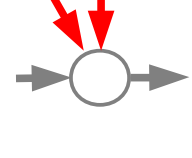
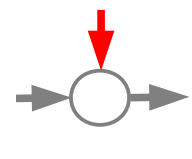
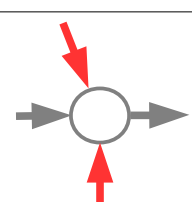
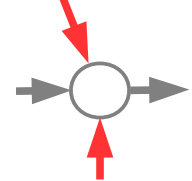
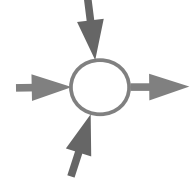
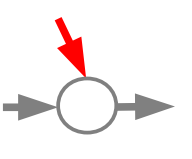
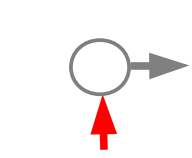
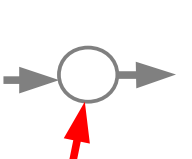

- rurowciąg kanalizacyjny \varnothing 0,2 PVC
- rurowciąg kanalizacyjny \varnothing 0,16 PVC
- rurowciąg ciśnieniowy PE

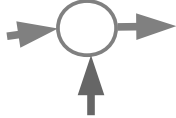
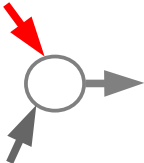
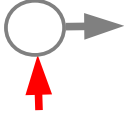
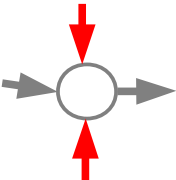
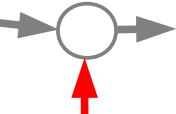
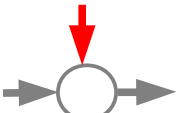
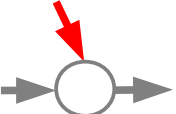
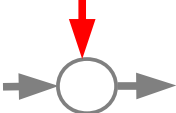
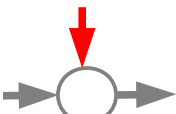
L.p.	Numer kanału	Numer studzienki	Rzędna terenu m n.p.m.	Rzędna dna m n.p.m.	Wysokość studzienki m (od wjazdu do dna kinety)	Średnica wewnętrzna studzienki mm	Układ i ilość rurowciągów (kąty podano na planach zagospodarowania terenu)
1.	KB1	B1	356,90	354,32	2,58	1200	+0,23
2.	KB1.1	B2	357,00	354,34	2,66	1200	
3.	KB1.1	B3	356,85	354,50	2,35	1200	
4.	KB1.1	B4	356,80	354,60	2,20	1200	
5.	KB1.1	B6	356,70	354,75	1,95	1200	
6.	KB1.1	B8	356,80	354,90	1,90	1200	

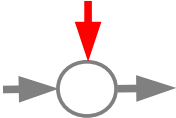
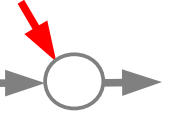
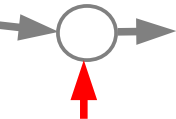
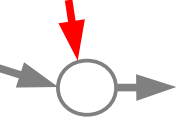

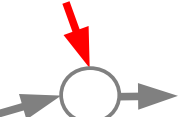
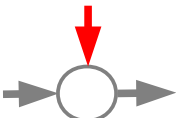
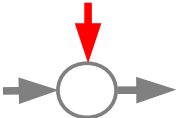
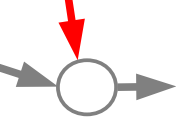

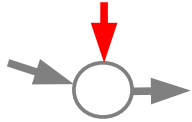
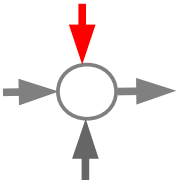
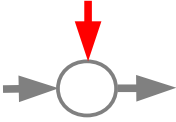
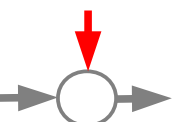
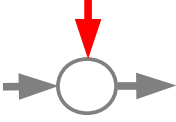
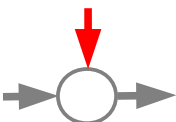
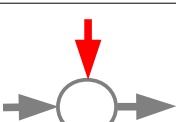

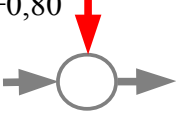

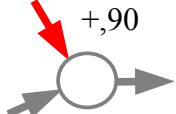
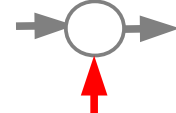
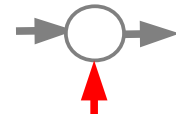
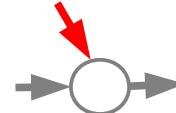
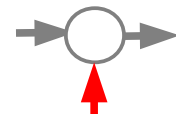
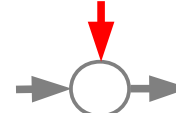
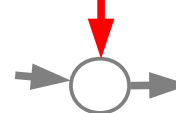
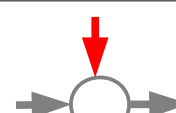
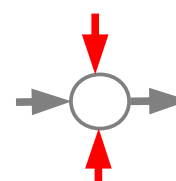

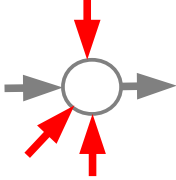
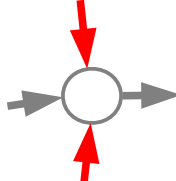
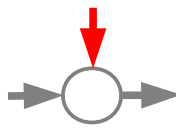
7.	KB1.1	B13	357,60	355,65	1,95	1200	
8.	KB1	B14	356,70	354,80	1,90	1000	
9.	KB1	B15	357,30	355,40	1,90	1000	
10.	KB1	B19	357,90	356,00	1,90	1000	
11.	KB1	B21	358,10	356,20	1,90	1200	
12.	KB1	B24	358,20	356,30	1,90	1200	
13.	KB1	B27	359,30	357,10	2,20	1200	
14.	KB1.2 A	B28	359,60	357,90	1,70	1000	
15.	KB1.2 A	B29C	361,00	358,45	2,55	1200	
16.	KB1.2	B30	359,80	357,80	2,00	1200	







17.	KB1	B32	359,70	357,60	2,10	1000	
18.	KB1	B33	359,70	357,75	1,95	1200	
19.	KB1.3	B34	359,80	357,85	1,95	1200	
20.	KB1.3	B36	359,70	357,95	1,75	1000	
21.	KB1	B38	360,50	358,50	2,00	1200	
22.	KB1	B40	361,00	358,90	2,10	1200	
23.	KB1	B42	361,40	359,10	2,30	1200	
24.	KB1	B44	361,40	359,20	2,20	1200	
25.	KB1	B47	362,20	360,00	2,20	1200	
26.	KB1	B50	362,80	360,90	1,90	1000	



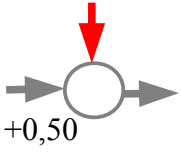
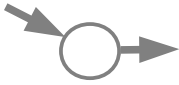
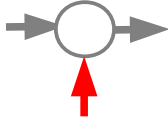

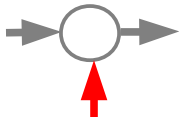
27.	KB1	B52	363,50	361,40	2,10	1000	
28.	KB1	B53	363,70	361,60	2,10	1200	
29.	KB1	B55	364,10	361,70	2,40	1200	
30.	KB1	B57	364,10	361,85	2,25	1000	
31.	KB1	B59	364,20	362,05	2,15	1000	
32.	KB1	B61	364,30	362,15	2,15	1200	
33.	KB1	B62	364,40	362,40	2,00	1000	
34.	KB1	B65	365,10	362,95	2,15	1000	
35.	KB1	B67	365,20	363,00	2,20	1200	
36.	KB1	B69	365,50	363,60	1,90	1000	

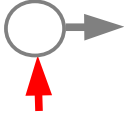

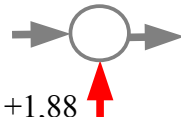
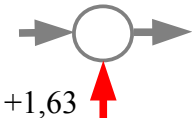

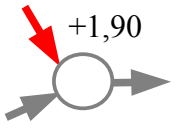
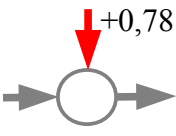
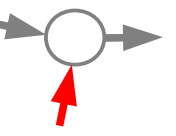
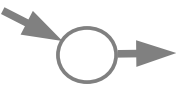
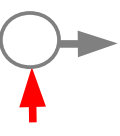
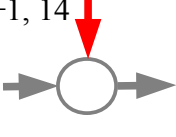
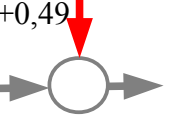

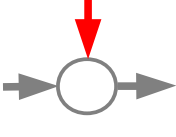
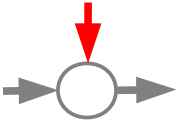
37.	KB1	B71	366,00	363,95	2,05	1200	
38.	KB1	B74	366,20	364,10	2,10	1200	
39.	KB1	B76	366,40	364,20	2,20	1200	
40.	KB1	B78	366,70	364,40	2,30	1000	
41.	KB1	B80	366,80	364,50	2,30	1200	
42.	KB1	B82	366,90	364,60	2,30	1000	
43.	KB1	B83	367,40	364,70	2,70	1200	
44.	KB1	B85	367,60	364,85	2,75	1200	
45.	KB1	B86	367,80	365,10	2,70	1000	+0,80 

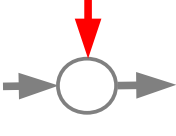

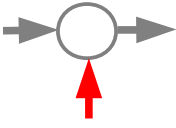
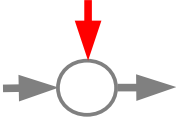
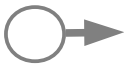
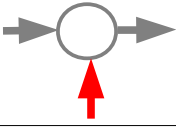

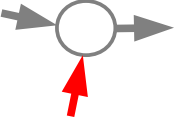
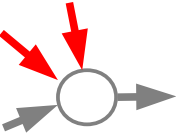

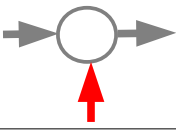
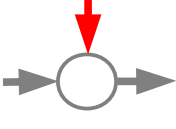
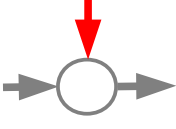
46.	KB1	B88	367,90	365,15	2,75	1000	+0,85 
47.	KB1	B90	368,00	365,20	2,80	1200	+90 
48.	KB1	B95	368,70	366,80	1,90	1000	
49.	KB1	B97	369,50	367,15	2,35	1000	
50.	KB1	B100	369,50	367,20	2,30	1200	
51.	KB1	B102	369,70	367,80	1,90	1000	
52.	KB1	B106	370,30	368,40	1,90	1200	
53.	KB1	B112	370,80	368,90	1,40	1000	
54.	KB1	B115	371,20	369,30	1,90	1000	
55.	KB1	B117	371,50	369,60	1,90	1200	



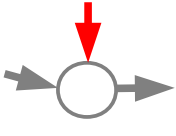

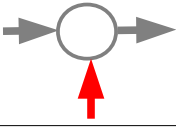
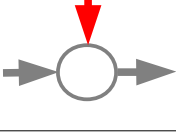

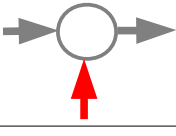
56.	KB1	B121	372,30	370,40	1,90	1200	
57.	KB1	B126	372,70	370,80	1,90	1200	
58.	KB1	B129	372,90	371,00	1,90	1200	
59.	KO	O1	353,20	351,75	1,45	1000	
60.	KO	O2	353,50	352,10	1,40	1000	
61.	KO	O3	353,90	352,50	1,40	1000	
62.	KO	O4	354,80	353,25	1,55	1000	
63.	KO	O5	355,70	353,50	2,20	1200	
64.	KO	O6	355,80	354,40	1,40	1000	
65.	KO	O7	356,30	354,90	1,40	1000	
66.	KO	O8	357,40	356,00	1,40	1000	
67.	1KN1.1	1N3	359,80	358,40	1,40	1000	

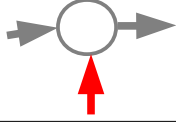
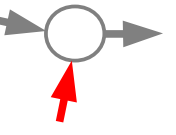
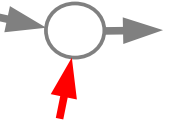
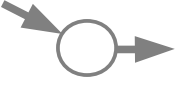



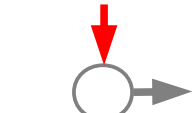

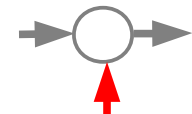
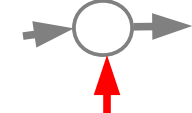
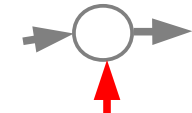
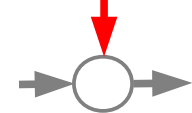
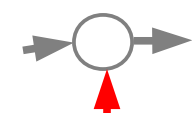

68.	1KN1.1	1N4	361,60	359,70	1,90	1200	
69.	1KN1.1	1N6	363,50	362,10	1,40	1000	
70.	1KN1.1	1N7	364,55	363,15	1,40	1000	
71.	KN1.1	1N8	365,20	363,80	1,20	1200	
72.	1KN1.1	1N9	366,45	367,90	1,40	1000	
73.	1KN1.1	1N11	367,50	366,10	1,40	1000	
74.	1KN1.1	1N12	368,35	366,60	1,75	1000	
75.	1KN1	1N14	360,50	357,20	3,30	1200	
76.	1KN1	1N15	361,05	357,40	3,65	1200	
77.	1KN1	1N16	361,00	357,52	3,48	1200	
78.	1KN1	1N18	361,00	357,57	3,43	1200	

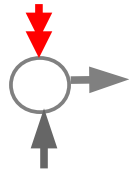
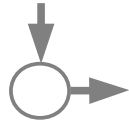
79.	1KN1	1N20	361,00	357,60	3,40	1200	
80.	1KN1	1N22	360,00	357,72	2,28	1200	
81.	1KN1	1N24	359,25	357,90	1,35	1000	
82.	1KN1	1N26	359,30	358,00	1,30	1000	
83.	1KN1	1N27	359,90	358,15	1,75	1000	
84.	2KN2	2N41	366,10	362,96	3,14	1200	
85.	2KN2	2N4	365,80	363,01	2,79	1200	
86.	2KN2	2N6	365,50	363,11	2,39	1200	
87.	2KN2	2N7	365,50	363,26	2,24	1200	
88.	2KN2	2N11	365,50	363,36	2,14	1200	
89.	2KN2	2N13	365,50	363,40	2,10	1200	
90.	2KN2	2N14	365,50	363,48	2,02	1200	

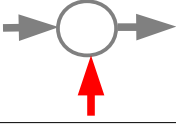
91.	2KN2	2N16	365,35	363,60	1,75	1000	
92.	2KN2	2N18	365,60	364,40	1,20	1000	
93.	2KN2	2N20	366,40	365,20	1,20	1000	
94.	2KN1	2N20A	367,10	365,40	1,20	1000	
95.	2KN1	2N22	367,30	365,55	1,75	1000	
96.	2KN1	2N23	367,50	365,63	1,87	1000	
97.	2KN1	2N25	367,60	365,70	1,90	1000	
98.	2KN1	2N29	367,90	366,20	1,70	1000	
99.	2KN1	2N30	367,90	366,30	1,60	1000	
100.	2KN1	2N32	368,30	366,60	1,70	1000	
101.	2KN1	2N34	368,60	366,90	1,70	1000	
102.	2KN1	2N36	368,65	367,02	1,63	1000	

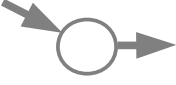
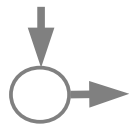
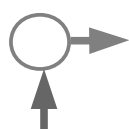
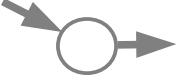
103.	2KN1	2N37	368,70	367,10	1,60	1000	
104.	2KN1	2N39	368,70	367,20	1,50	1000	
105.	2KN1	2N40	369,00	367,50	1,50	1000	
106.	2KN1	2N41	369,20	367,80	1,40	1000	
107.	2KN1	2N43	369,80	368,20	1,60	1000	
108.	2KN1	2N45	370,30	368,70	1,60	1000	
109.	2KN1	2N45A	370,30	368,75	1,55	1000	
110.	2KN1	2N46	370,30	368,90	1,40	1000	
111.	2KN1	2N47	371,00	369,60	1,40	1000	
112.	2KN1	2N49	372,50	371,10	1,40	1000	
113.	2KN1	2N51	373,40	372,00	1,40	1000	
114.	2KN1	2N54	373,60	372,10	1,50	1000	

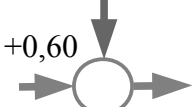
115.	2KN1	2N55	374,20	372,50	1,70	1000	
116.	3KN2	3N1	372,40	371	1,40	1000	
117.	3KN2	3N2	373,35	371,95	1,40	1000	
118.	3KN2	3N3	374,50	373,10	1,40	1000	
119.	3KN1	3N7	375,60	372,67	2,93	1200	
120.	3KN1	3N8	374,90	372,83	2,07	1000	
121.	3KN1	3N10	375,10	373,20	1,90	1000	
122.	3KN1	3N12	375,30	373,40	1,90	1200	
123.	3KN1	3N14	375,70	373,80	1,90	1000	
124.	3KN1	3N18	376,20	374,30	1,90	1000	
125.	3KN1	3N20	376,50	374,45	2,05	1200	
126.	3KN1	3N22	376,80	374,60	2,20	1000	

127.	3KN1	3N23	377,60	375,30	2,30	1200	
128.	3KN1	3N27	379,25	377,33	1,92	1200	
129.	3KN1	3N29	379,20	377,40	1,80	1000	
130.	3KN1	3N30	380,50	378,85	1,65	1000	
131.	3KN1	3N31	380,80	379,00	1,80	1000	
132.	3KN1	3N34	381,40	379,39	2,01	1200	
133.	3KN1	3N35	381,40	379,41	1,99	1200	
134.	3KN1	3N36	382,00	379,64	2,36	1200	
135.	3KN1	3N37	381,80	379,70	2,10	1200	
136.	3KN1	3N38	382,40	379,95	2,45	1200	
137.	3KN1	3N39	382,40	380,10	2,30	1000	
138.	3KN1	3N40	383,30	380,90	2,40	1200	
139.	3KN1	3N47	385,30	383,10	2,20	1000	

140.	3KN1	3N48	385,80	383,50	2,30	1200	
141.	3KN1	3N51	385,90	384,00	1,90	1000	
142.	KG1.1	G6	375,30	372,00	3,30	1000	
143.	KG1	G16	374,80	373,40	1,40	1000	
144.	KG1	G17	377,00	375,60	1,40	1000	
145.	KG1	G19	379,20	377,80	1,40	1000	
146.	KG1	G22	381,00	379,60	1,40	1000	
147.	KG1	G22	384,90	383,50	1,40	1000	
148.	KG1	G24	388,20	386,80	1,40	1000	
149.	KG1	G25	390,00	388,60	1,40	1000	
150.	KG1	G26	392,70	391,30	1,40	1000	

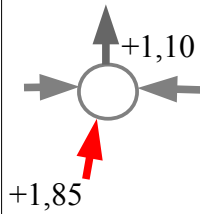
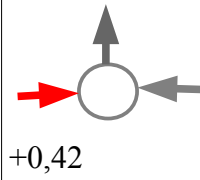
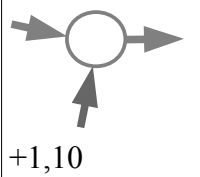
151.	1KN1	1N1	360,50	357,15	3,35	1200	
152.	KG1	G1	374,30	371,88	2,42	1000	
153.	KG1	G3	374,40	371,90	2,50	1000	

Studzienki 3N28, 3N42, 3N43, 3N44 (dla przyłączy ciśnieniowych) wykonać wg załączonego poniżej schematu (trójniki oprzeć na podporach betonowych).

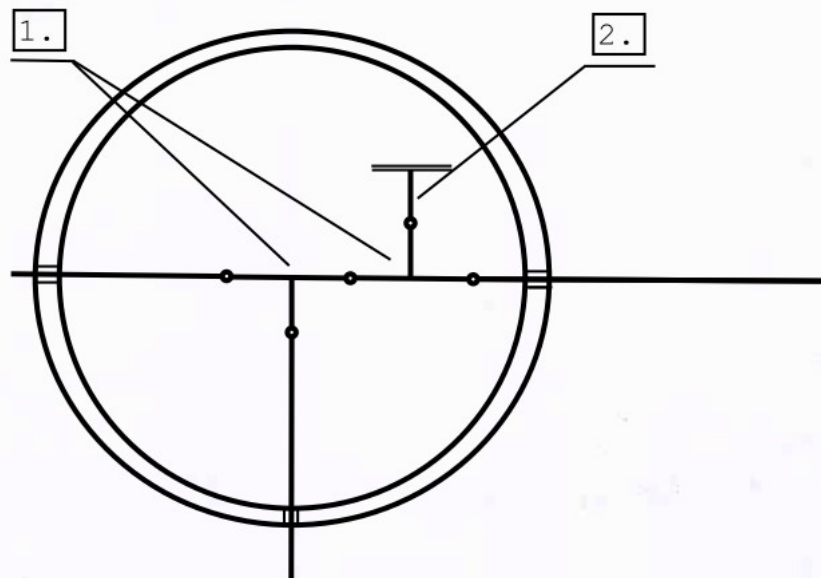
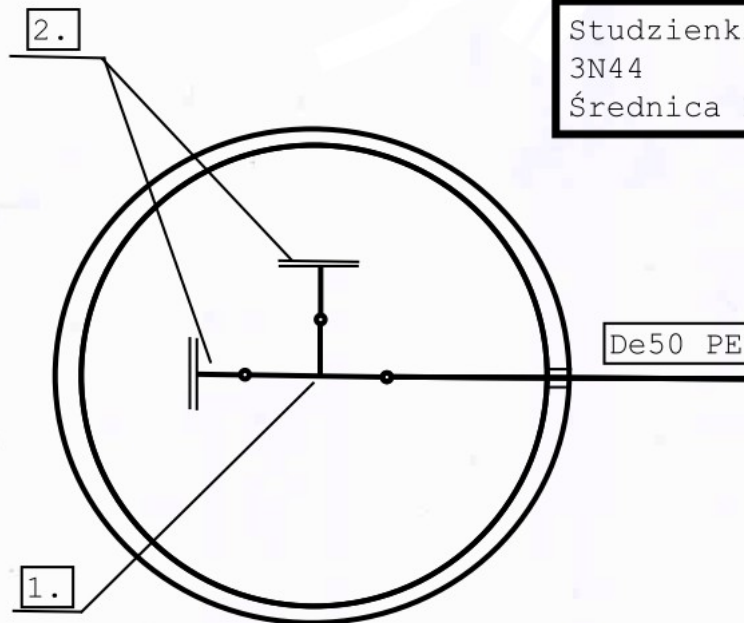

1. Trójnik bosy równoprzelotowy De 50/50 PE PN10
2. Tuleja kołnierzowa PE De/dn 50/40 z kołnierzem luźnym De/dn 50/40 stal. PN10

Uwagi:

- rzędną terenu w miejscu posadowienia studzienki można oszacować na podstawie planu sytuacyjnego z dokładnością co najwyżej 0,1 m. Na istniejących terenach utwardzonych (drogi, podwórka) włącz studzienki powinien znajdować się równo z powierzchnią terenu. W innych przypadkach powinien być wyniesiony ponad teren o kilka centymetrów ,
- studzienki spadowe /kaskadowe – opisane na profilach/ – rozwiązanie z rurą spadową \varnothing 0,2 PVC na zewnątrz studzienki, z zastosowaniem trójnika i kolana 90° (obetonować).